

Saltfork Craftsmen Artist-Blacksmith Association

September 2019

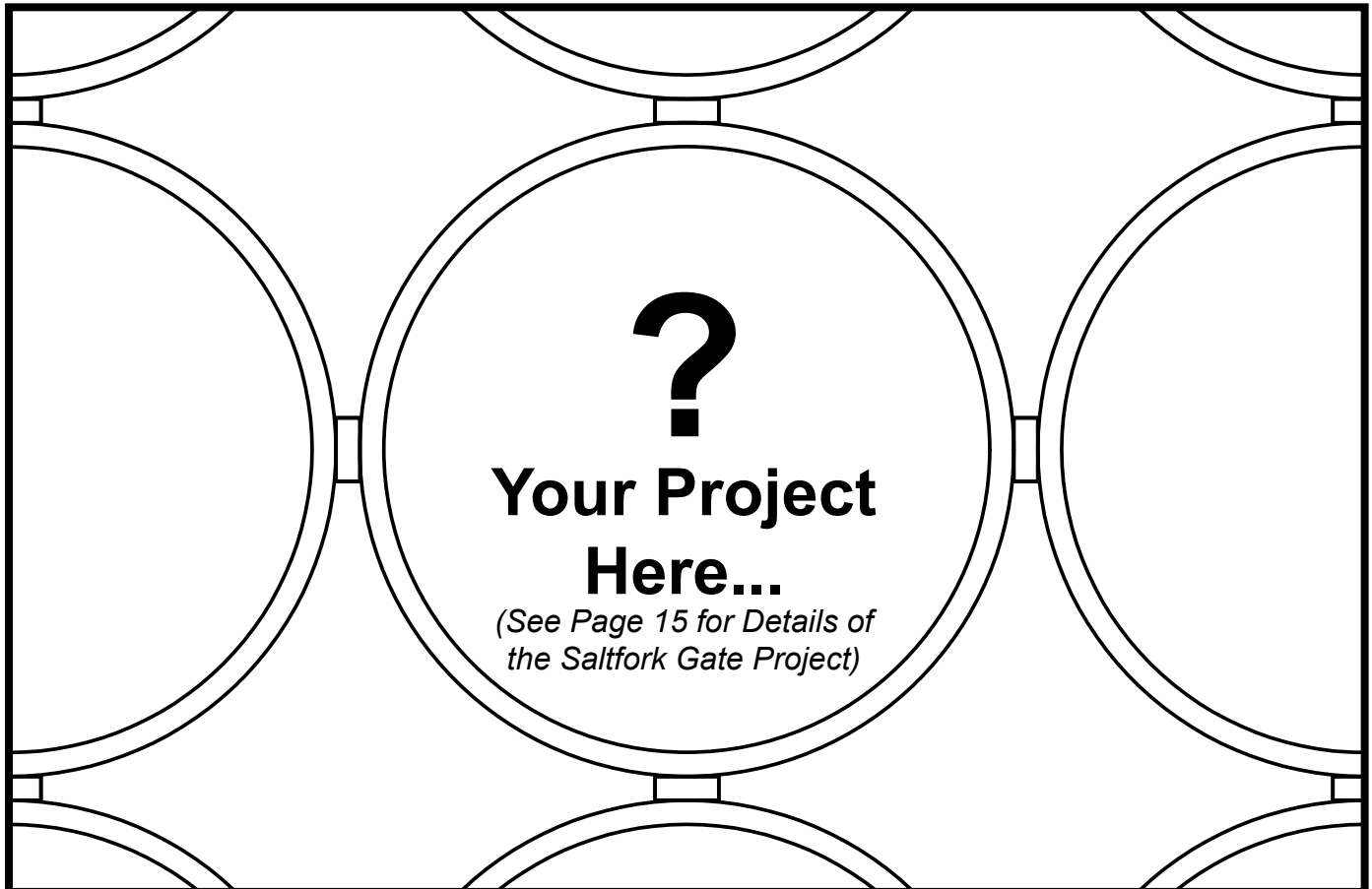

The 2019 Annual Saltfork Conference is Next Month!

Conference October 19th and 20th

See page 16 for Conference flyer and registration form.

The best way to register is online through the website.

Be sure to register as soon as possible!

Find an extra bonus in your welcome packet if paid registration is received on or before Monday October 14th.

**Saltfork Craftsmen
Artist-Blacksmith Association
Officers and Directors**

President/Workshop Coordinator:

Mandell Greteman 580-515-1292
409 East Broadway
Foss, Okla. 73647 mandell01@windstream.net

Vice-President/Conference Chair:

JJ McGill 580-369-1042
5399 Pete Nelson Rd.
Davis, OK 73030 jjmcgill88@yahoo.com

Director:

Byron Doner 405-650-7520
6520 Alameda
Norman OK 73026 byrondoner@esok.us

Director:

Ricky Vardell 580-512-8006
P.O. Box 461
Temple, OK 73568 Rickyv.vardell@gmail.com

Director:

Don Garner 580-302-1845
23713 E 860 Rd
Thomas, OK 73669 Call or Text

Director:

Eric Jergensen 405-414-8848
625 NW 18th
Oklahoma City, OK 73103 gericjergensen@gmail.com

Director:

Russell Bartling 918-633-0234
70 N 160th W. Ave
Sand Springs, Ok 74063 rbartling@ionet.net

Assignments:

Secretary:

Carol Doner 405-760-8388
6520 Alameda
Norman OK 73026 caroldoner7@gmail.com

Treasurer:

Teresa Gabrish 405-824-9681
P.O. Box 18389
Oklahoma City, Ok. 73154 tgabrish@gmail.com

Editor/Regional Meeting Coordinator:

Russell Bartling 918-633-0234
70 N 160th W. Ave
Sand Springs, Ok 74063 rbartling@ionet.net

Webmaster:

Dodie O'Bryan
Pawnee, Ok scout@skally.net

Librarian:

Don Garner 580-302-1845
23713 E 860 Rd
Thomas, OK 73669
Call or Text. If you get voice mail, please leave a message.

Conference Set Up Work Day!

There is a Pre-Conference set up work day scheduled for October 12th at the Conference site in Sulphur (This is the Saturday one week before the Conference.)

If you are interested in helping set up for the Conference, please attend that day.

Set up will include placing the bleachers, installing the audio-visual equipment infrastructure, moving various items around, etc. None of it is hard work if enough people come to help.

There will be a lot of camaraderie among those elite volunteers who choose to attend. And if you don't show up, the rest of us will surely talk about you. (Just kidding. Of course that would never happen...)

- Editor

The Saltfork Craftsmen Artist-Blacksmith Association, a non-profit organization Our purposes are the sharing of knowledge, education and to promote a more general appreciation of the fine craftsmanship everywhere. We are a chapter of the Artist-Blacksmith Association of North America.

Material from this newsletter may be freely copied without permission for non-profit purposes. Please credit the author and this publication.

Visit our Saltfork Craftsmen Website:
www.saltforkcraftsmen.org

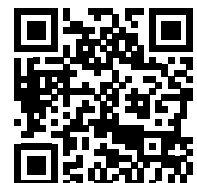

President's Notes:

Well another month has gone by too fast. It has been very warm - down right HOT! Its a job just to try and stay cool. Its bad when you go outside of the shop to get steel off the rack and you have to wear gloves to keep from burning your hands. You sure don't have to pre-heat your anvil!

I went to a regional meeting the other day and it was pleasantly surprising to see a lot of new people. They had a lot of interest in blacksmithing. That's great because it takes new interest to help keep the club going, along with all the ones that have been here awhile.

Our conference will be here soon and we have two very good demonstrators. I think everyone will really like them & they are going to teach hands-on workshops after the conference. This is a great opportunity to get access to personal instruction with these smiths. I hope we have good weather and a good attendance for the conference this year. If you don't make it, you are really going to miss a lot of good forging and a lot of fun.

We would like to see a lot of projects in the Conference Galleries this year, it gives everyone new ideas and inspiration. We would like too see a good turn out for the Peoples' Choice this year. And it really helps the club to get a lot of items for the Iron in the Hat, the Conference Toolbox and for the Conference Auction. I would like to thank everyone who helps the club with all of your projects and donations.

The Oklahoma State Fair and Tulsa State Fair are going to be here this month. We need people to demo at each one of them. If you are interested, please consider representing Saltfork at these events.

Keep your hammer handles tight.

- Mandell Greteman



All Regional Meetings are Free to Attend and are Always Open to Any Member or Guest...

New to Saltfork or just want to check out Blacksmithing but don't know where to start? These meetings are a great place for new members or guests who just want to see what it is all about to come network with like minded people. If you want some pointers on how to get started, there is always someone happy to help get you started hammering. And guests are always welcomed.

Want to host a meeting? The meeting hosting form can be found on the last page along with membership application form. If you want to host a meeting in any area please fill out one of the host forms on the website under the calendar section or in the newsletter and e-mail the information or mail the hard copy form in as soon as possible. If you mail a form, please call or e-mail to verify that it is received. E-mail is the most convenient for me but you can also phone in the information if you prefer. The sooner the meeting is scheduled, the more time there is to get the word out to potential attendees. -Russell Bartling 918-633-0234 or rbartling@ionet.net

What's My Region?

The four main regions are currently defined within the state by being separated by I35 and I40. (For example, the NW region is anything north of I40 and west of I35.)

All meetings are encouraged. These boundary definitions and regional meeting dates are a suggested framework to facilitate orderly meeting scheduling, planning and promotion with a minimum of overlaps and a maximum exposure to the greatest number of members. Not all meetings fit precisely within a rigid boundary definition and members in an area may want to hold meetings on a date that doesn't match their physical region or at a location other than their own region. This may be especially true in the center of state for areas that are close to the I35 and I40 boundary crossing. Special events such as shows, fairs, etc. may also dictate adjustments to the meeting dates within a region.

SCABA Regions

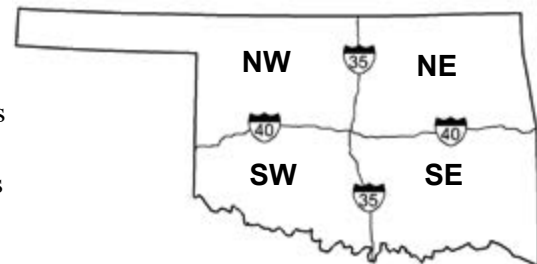

The regions are meant to be a simplification and clarification to the regional boundaries rather than a rigid restriction to any meeting scenario. ***Saltfork members all belong to one club.*** Regional boundaries are not intended to imply division within the club, but are intended to help spread distribution and promote monthly meetings.

Safety

Blacksmithing can be an inherently dangerous exercise. There is no substitute for personal responsibility and common sense and no list of safety rules can adequately cover every situation. Every person who attends a meeting, demonstration or event sponsored by the Saltfork Craftsmen Artist Blacksmith Association (SCABA) or its members does so at their own risk and assumes all responsibility for their own safety needs. The SCABA organization, its officers, members, demonstrators, volunteers and guests disclaim any responsibility for any damages, injuries, or destruction of property resulting from the use of any information or methods published or distributed by SCABA or demonstrated at workshops, meetings, conferences or other events. SCABA recommends proper attire and safety gear and standard shop safety procedures appropriate for blacksmithing and shop work during any event where blacksmithing and other related methods are involved. Safety attire includes, but is not limited to, appropriate clothing, eyewear, hearing protection, gloves, and face shields when appropriate. It is every individual's responsibility to provide for their own safety, to determine what safety gear is appropriate for each situation and to provide, maintain and use that gear as appropriate for each individual situation.

2019 Workshop Schedule

Demonstrator Workshops are scheduled after the Conference in October with limited seats available - see page 20.

****NEW** Beginner Blacksmith Class **NEW****

Saturday, November 2nd: 8:00 AM until done. Muldrow, OK

Host and Contact: Brad Nance
918-744-4291
bradley.nance@cnet.com

Instructors will also include Tracy Cowart and Chuck Waite. Registration fee is \$40, Lunch provided. Participants need leather gloves, long pants, decent shoes (no open toes) and eye protection. Tools and materials will be provided. Limited slots available so please register early. Projects covered will include an "S" hook, a leaf, a hot cut chisel, and a forge welded flux spoon. The venue is open to the public but the class will be for registered participants only. Contact Brad Nance by phone call, text or e-mail to register.

Location: Muldrow City Park at West Shawntel Smith Blvd., Muldrow, OK 74948.

Mandell would like to schedule a tong making class for late fall or winter if there is enough interest. If you would be interested in attending this class, let Mandell know. If there is enough interest, a date will be scheduled and details announced. Otherwise, the class will not be held.

Have an idea for a workshop or class? If you have an idea for a workshop that you would like to attend (or teach), please let the workshop coordinator know so that details for time and place can be worked out.

**Mandell Greteman is the SCABA Workshop Coordinator.
Contact Mandell at 580-515-1292.**

2019 REGIONAL MEETING SCHEDULE

NE Region (1st Sat)	SE Region (2nd Sat)	SW Region (3rd Sat)	NW Region (4th Sat)
Jan 5th (Josh Perkins) (Unless Other Host Interested)	Jan 12th (Byron Doner)	Jan 19th (Open)	Jan 26th (Rory Kirk)
Feb 2nd (James Schaefer)	Feb 9th (Open)	Feb 16th (Open)	Feb 23rd (Monte Smith)
Mar 2nd (Josh Perkins) (Unless Other Host Interested)	Mar 9th (Open)	Mar 16th (Bruce Willenberg)	Mar 23rd (Mandell Greteman)
Apr 6th (Diana Simon- Cherokee Strip Hist. So- ciety)	Apr 13th SCABA Picnic	Apr 20th (Open)	Apr 27th (Rory Kirk)
May 4th (Josh Perkins) (Unless Other Host Inter- ested)	May 11th (Open)	May 18th (Open)	May 25th (NW-Terry Kauk)
			May 25th (SW-JJ McGill, Boy Scouts)
Jun 1st (Josh Perkins) (Unless Other Host Inter- ested)	Jun 8th (Open)	Jun 15th (Ricky Vardell)	Jun 22nd (Mandell Greteman)
Jul 6th (Open)	Jul 13th (Open)	Jul 20th (Open)	Jul 27th (Open)
Aug 3rd (Open)	Aug 10th (Joe Hamil)	Aug 17th (Open)	Aug 24th (Mandell Greteman)
Sep 7th (Tracy Cowart)	Sep 14th (Open)	Sep 21st (Ricky Vardell - JJ McGill - Sulphur Tractor Show)	Sep 28th (Ron Lehen- Bauer as Host - Don Gar- ner as Contact Person)
Oct 5th (Diana Simon-Cherokee Strip Museum)	Oct 12th (Conference Setup Work Day)	Oct 19th (Conference Weekend!)	Oct 26th (Bob Kennemer)
Nov 2nd (Diana Simon-Cherokee Strip Museum)	Nov 9th (Bill Phillips)	Nov 16th (Anthony Griggs)	Nov 23rd (Open)
Dec 7th (Open)	Dec 14th (Open)	Dec 21st (Open)	Dec 28th (Open)

2019 Fifth Saturdays:

March 30th (Beginner Blacksmith Classes Planned for NE and NW Regions. Touchmark Class at Byron Doner's Shop.)

June 29th (Knife Basics Class with ABS Journeyman Anthony Griggs!)

August 31st (Open)

November 30th (Open)

September 2019

NE Regional Meeting September 7th: Will be hosted by Tracy Cowart at 10380 N 4010 Road, Wann, OK 74083. (See map on next page.)

Instead of a Trade Item, we will be making tongs or pliers, etc. for the Conference or Auction. Lunch is provided but please bring a side dish or dessert to help out.

Contact Tracy Cowart at 918-630-7025 or gtcowart@gmail.com if you have questions.

SE Regional Meeting September 14th: Open.

SW Regional Meeting September 21st: Will be hosted by Ricky Vardell and J.J. McGill in conjunction with the Murray County Antique Tractor & Implement Association Show.

The trade item is a clevis. Four to five inches from center hole with half inch pin and keeper.

Lunch will be on your own. The blacksmiths are invited to a thank you dinner by the Tractor Club at 6PM. Directions are 7 miles north of Sulphur on Hwy 177 then east ¾ mile on Tractor Road. If you need more information, contact Ricky Vardell at 580-512-8006 or JJ McGill at 580-369-1042.

NW Regional Meeting September 28th: Will be hosted by Ron Lehenbaur (Don Garner as contact) at the Fairview Tractor Show. Directions: 1 ½ miles east of Fairview on Hwy 58. Watch for signs on the north side of the road.

The trade item is a Pintle Hinge. Lunch will be provided but please bring a side dish or dessert to help out. Contact: Don Garner 580-302-1845 if you have questions.

October 2019

NE Regional Meeting October 5th : Will be hosted by Diana Simon and the Cherokee Strip Historical Society at the new Blacksmith Museum and Shop. 2617 W. Fir Ave, Perry, OK 73077. The shop is located approximately 1/4 mile east of Exit 186 from I-35 on north side of the road (Hwy 64 or Fir St.)

The trade item is a Trivet.

The meeting is planned to start at 9:00 AM.

Lunch will be provided. Please bring a side dish or desert to help out.

Contact Diana Simon at 580-572-8290 or dsimon@gmail.com if you have questions.

SE Regional Meeting October 12th: Is reserved for the Pre-Conference Set Up Work Day in Sulphur, OK. Please come help get the site ready for the Conference if you can!

SW Regional Meeting October 19th : **Conference Weekend!**

NW Regional Meeting October 26th : Will be hosted by Bob Kennemer at the Route 66 Museum Blacksmith Shop in Elk City, OK.

Lunch will be provided but please bring a side dish or dessert to help out.

The Trade Item is a wall hook. Contact Bob Kennemer at 580-799-1878 if you have questions.

Map to Dan Cowart's Shop

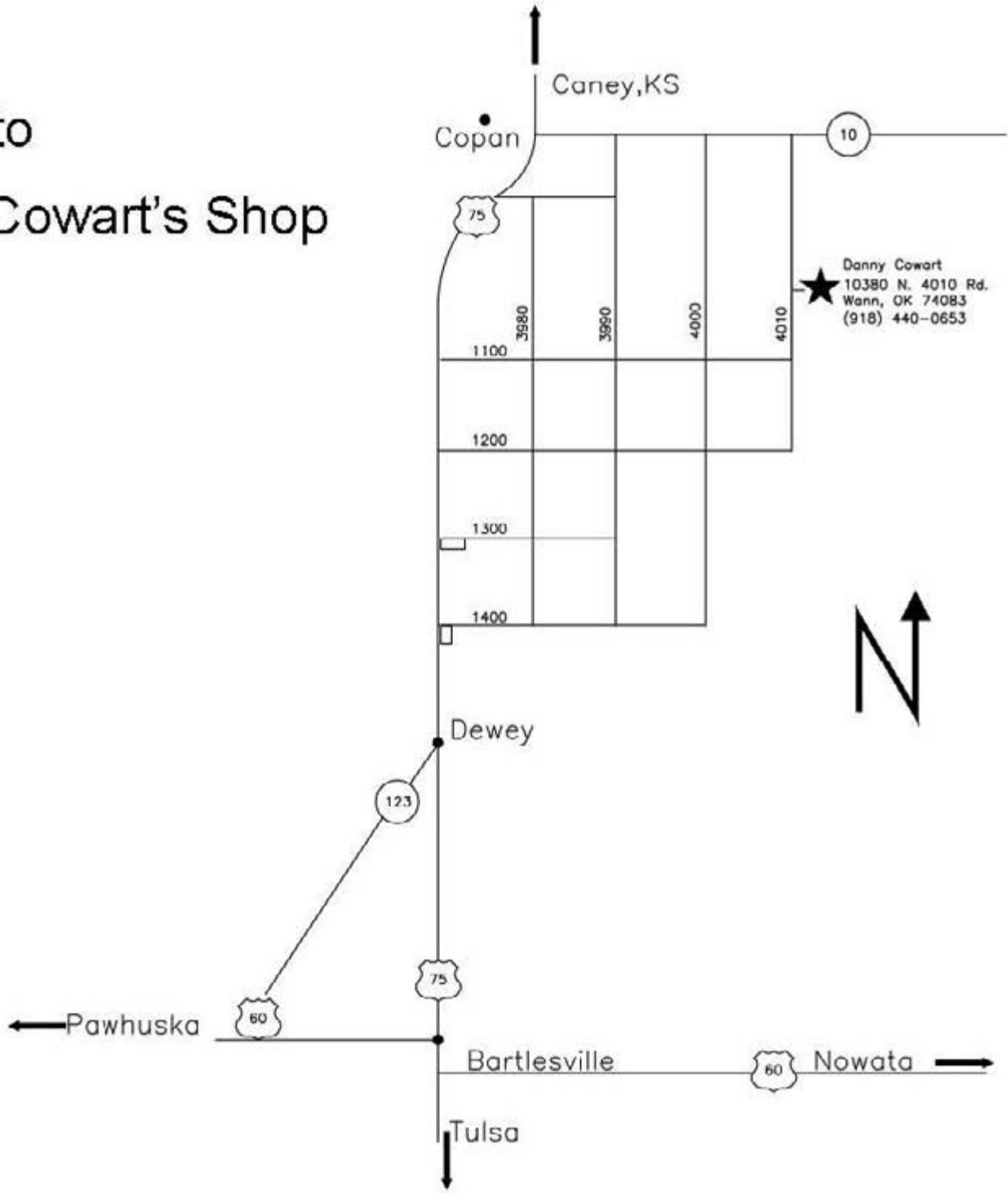

CENTRAL STATES

HAMMER IN & KNIFE SHOW

Helton Custom Knives
18633 S. Fern Place
Claremore, OK 74019
(918) 230-1773

HOSTED BY
BILLY HELTON
AT
HELTON CUSTOM KNIVES

SATURDAY, SEPT. 21, 2019
9 AM - 5 PM

COME AND MEET
SMITHS FROM THE
HISTORY
CHANNEL'S
FORGED IN
FIRE

FREE ADMISSION
OPEN TO THE PUBLIC

DEMONSTRATIONS BY SMITHS THROUGHOUT THE DAY



RAY KIRK
FORGED
INTEGRAL
KNIFE

STEVE CULVER
FORGE
BUILDING



ALLEN NEWBERRY
DELFT
CLAY
CASTING

BRION TOMBERLIN
HAMON LINES



TAD LYNCH
DOMED
PINS

PAUL BROWN
KNIFE
GRINDING
TECHNIQUES



GARY MULKEY
MOSAIC
DAMASCUS



CUTTING COMPETITION HELD BY JO SMITH FROM 1 PM - 2 PM

THERE WILL BE CONCESSIONS AVAILABLE ON SITE

GRAPHICS BY BUDDY THOMAS, TREE OF LIBERTY BLADECRAFT & FORGE

Around the State...

NW Region July Meeting:

No meeting was held in July.

NE Region August Meeting:

No Meeting was held in August.

SE Region August Meeting:

The SE Meeting in August was held at the EWS store in Norman, OK. We had 41 sign in but we figured another 25 came through to see what was happening and grabbed a hotdog since the sign-in sheet was put out late. Among the attendees where some new friends that have never been around the craft before, at least 3 of them are hooked and can't wait until they get the chance to hammer some more.

We had 2 forges, 2 anvils and a vice set up. Thanks Byron and Bruce for bringing the teaching trailer. Thanks Mr. Gerald, Jason and Travis and others that did some demonstrations. Larry set up a little stand and showed the art of metal finishing. Thanks Bruce and Nolan, they did the grilling of hotdogs, hotlinks, brats and chili. A big thank you to all the folks at EWS and others for pitching in and making the day great.

Trade items were pot luck and I was not disappointed. We had 7 items and I wish I could have drawn them all. Being a novice I have only been to one other meeting, but with the SCABA Family's help, (they did most of it) I will be glad to host another one sometime.

On a personal note, watching other novice and first timers take advantage of the knowledge of the skilled blacksmiths was pretty neat. Even though it was hot, very hot, they asked questions and all the members jumped in to help them all.

Until next time...

Thanks y'all! - Joe Hamil









SW Region July Meeting: No meeting was held in July.

Member Gallery

Cross by Mark Carter

Here is a five foot cross I built for a couple of professors at OSU. The large picture is in my shop and the other is installed in the client's home. It was inspired by grave markers in an old German cemetery. - Mark Carter



Saltfork Gate Project!

This is a new group project that is open to all Saltfork members. The project is a four foot high by sixteen foot long gate to be displayed outside at the Route 66 Blacksmith Shop Museum at Elk City.

Participating members will be given a steel ring that can be filled with any (family appropriate) forged work that will fit in the ring and be permanently attached to it. Each ring is 10 1/4" O.D. and made of 3/8" round. Most of the rings will be connected at the four cardinal direction points (N, S, E, W) by welding. A small spacer of 1" by 3/8" will be placed between the connection points of each ring.

Try to keep the projects inside the rings from projecting more than approximately 4" out from either face. Otherwise, the design and connection methods to the ring are strictly up to you.

There will be a central large ring with a Saltfork Craftsmen title.

Mandell Greteman is coordinating the project and will provide the standardized rings. All of the rings will be provided to ensure they are a standardized size. Once the projects are returned, Mandell will weld them into the gate to be displayed at the museum.

There is space for 56 ring projects in this gate. If there are more participants, additional gates will be made and installed inside the blacksmith shop.

Contact Mandell if you have any additional questions or to find out where to obtain one of the project rings: **Mandell Greteman 580-515-1292.**

Concept Sketch for the Gate Project:



The 23rd Annual

Saltfork Craftsmen Artist Blacksmith Association Conference

October 19th & 20th 2019



Featuring Live Blacksmithing
Demonstrations by:

Peter Ross

and

Ken and Mary Lou Zitur

Murray County Antique Tractor Association Show Grounds:

7 miles north of Sulphur on Hwy
177, ¾ mile east on Tractor
Road. Sulphur, OK

Conference Schedule



Friday, October 18th

Conference setup starting at 8:00 am.

Saturday, October 19th

Registration opens at 7:00 a.m.
Demonstrations 8:00 am – Noon
Lunch break Noon – 1:00 p.m.
Demonstrations 1:00 – 5:00 p.m.
Dinner 6:00 p.m.
Drawing for toolbox 7:00 p.m.
Auction 7:00 p.m.



Sunday, October 20th

Registration Opens at 7:00 a.m.
Demonstrations 8:00 – 11:30 a.m.
Lunch Break 11:30 – 12:30 p.m.
Demonstrations 12:45 – 4:00 p.m.
Cleanup and teardown 4:00 p.m.



Conference Set Up Work Day!

There is a Pre-Conference set up work day scheduled for Saturday October 12th at the conference site (the Saturday before the conference.)

If you are interested in helping set up for the conference, please feel free to attend that day. Set up will include placing the bleachers, installing the audio visual equipment, moving various items around, etc. There will be a lot of camaraderie among those elite volunteers who choose to attend.

There is never enough help to go around so please come lend a hand if you can! See you there!

23rd Annual Saltfork Craftsmen Blacksmithing Conference

Registration Form
October 19th & 20th, 2019

Please Print Clearly

Name: _____ Spouse Name: _____

Address: _____

Phone: _____ E-Mail: _____

Membership required for attendance.

Charge for non-members is \$30 for membership

	Number	Cost Each	Total
Conference Registration Fee (One Per Family)			
Saturday & Sunday (per family)		\$55.00	
Saturday Only (per family)		\$35.00	
Sunday Only (per family)		\$35.00	
Membership for Non-Members		\$30.00	
Meals			
By donation at time of meal. Donation Jar will be set out when meal is served			
*Family Classes on Saturday			
Saturday Morning: Leather Bracelet		\$45.00	
Copper Etching Class		\$45.00	
Saturday Afternoon: Leather Earrings		\$50.00	
China Necklace Class		\$45.00	
*Family Classes on Sunday			
Sunday Morning: Birdhouse Pendant		\$45.00	
Sunday Afternoon: Spoon Bracelet		\$45.00	
Total Payment Enclosed			

Make checks payable to Saltfork Craftsmen ABA.

Only one family Registration Fee (family members only) required per household.
(All meals and all material costs for Family Classes must be paid).
Saltfork Craftsmen T-shirts will be available at the conference.

Murray County Antique Tractor Association Show Grounds:

7 miles north of Sulphur on Hwy 177, ¼ mile east on Tractor Road. Sulphur, OK

Mail this form with full payment to:

Teresa Gabrish
322 Washington
Blanchard, OK 73010

All adults attending the conference must sign this disclaimer. Parent or legal guardian must sign for minor children.

Disclaimer: I understand that blacksmithing can be a dangerous endeavor. I understand that my safety is my responsibility. I understand the need for eye and ear protection; I will provide and utilize the necessary safety equipment for all activities. The Saltfork Craftsmen ABA, its officers and members are not responsible for my well-being. Registration for the Conference indicates my agreement to these terms.

Signature: _____ Date: _____

Signature: _____ Date: _____

Family Classes:



Broken China Necklace:

Make these colorful pendants from bits of broken china with Joann Cochran



Birdhouse Pendant made from Silverware Handle: Joann will show you how to make this adorable little birdhouse pendant from the handle of a butter knife.



Spoon Bracelet:

In this class you will take beads and the handles from two spoons to make this cute bracelet.



Copper Etched Pendant: Joann is showing us how to etch on copper then cut it into a shape for a pendant.

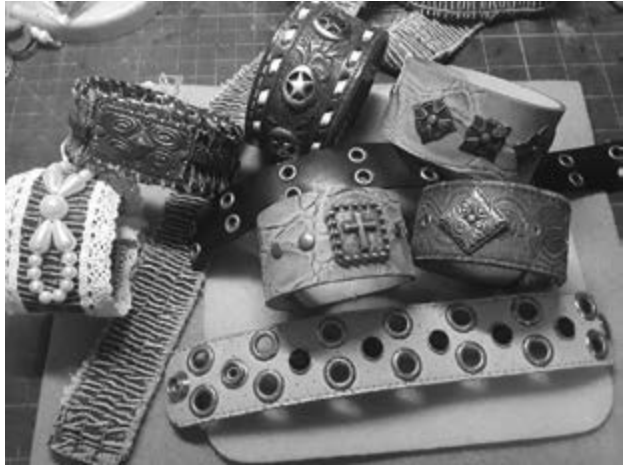

Leather Bracelets: Anita Lamb will show you how to make leather cuff bracelets. The picture is just examples of the many styles that can be done. You will make as many as time allows for your \$45.



Leather Earrings: Anita is going to show us how to make some really creative earrings out of leather. You will be able to make multiple pairs of earrings during the time aloud.

If anyone has suggestions for additional classes or classes for next year please contact Teresa at tgabrish@gmail.com.

2019 SCABA Conference RV Reservations:

It is not too early to make reservations if you plan on camping on site and need an RV hookup. Primitive camping is also available with access to clean toilets and showers if you prefer primitive camping. RV hookups are available for \$15 per RV per night (to the Tractor Club) for electric only service. Spots are already being reserved so contact J. J. McGill as soon as possible if you would like to make a reservation.

Contact J. J. McGill at 580-369-1042 or jjmcgill88@yahoo.com



2019 SCABA Conference

October 19th and 20th

Sulphur, OK



Demonstrators: Peter Ross and Ken Zitur

Conference Workshops October 21, 22 and 23rd:

SCABA has set up on site workshops with the demonstrators - Peter Ross and Ken Zitur - after the conference. Each demonstrator will conduct a 10 student workshop over three days following the conference (Monday through Wednesday). The workshops will run concurrently so you will only be able to register with one instructor. This is an amazing opportunity to receive hands on instruction with instructors of this caliber.

Participants must provide their own (or arrange to borrow) safety gear and forging stations including anvil, forge, vice, and basic forging tools such as hammers, tongs, chisels, and punches etc. Specific tooling requirements for any tools that will not be provided will be made available before the workshops.

These may not be beginner classes and basic forging abilities will be required. (You do not have to be an expert, there will always be others to help you through challenges. And stretching our abilities is part of the point of these workshops. But if you are just learning to forge, these workshops may be difficult.)

Participants are first come, first served and must call, text or e-mail Eric Jergensen to register. Registration will open September 1st at 2 PM. Contact Eric by phone call, text or e-mail to secure your place in a class. Calls, texts or e-mails prior to registration opening time will not be accepted.

The Peter Ross workshop will be forging colonial box joint pliers using traditional methods. This will be an intensive class to complete in three days and will consist of smith and striker teams working together.

The Ken Zitur workshop will be making tools to forge a hand hammer and then making a hand hammer with those tools. If time allows, an additional tooling project may be included (depends on class progress.)

Cost for a workshop is \$350 per student including meals. Registration fee will need to be paid in full by October 1st or you may lose your place in the workshop. Cancellations will be accepted for a 50% refund up to October 6th. After that, the registration fee will be non-refundable.

If you have registered for the workshops, additional details will be provided as available.

If you have any questions, contact **Eric Jergensen at 405-414-8848 or gericjergensen@gmail.com**

Note: Due to current finances, After-Conference Workshop Scholarships will not be available for 2019.

2019 SCABA Annual Conference

Peoples' Choice Awards and General Gallery

Two Categories:

This year, just like last year, we will have **two categories**, one will be for work done using “**Traditional**” methods and the other will be “**Open**,” meaning open to use any and all methods of the artist’s choosing.

As soon as we start placing labels on art and craft work, it becomes difficult to avoid creating overly limiting definitions to clarify those labels. The intent here is to separate work that is done with methods generally considered traditional to blacksmithing, such as forge welding, joinery, punching, upsetting, drawing out, etc. from more modern methods such as arc/mig/gas welding, stock removal grinding, etc. These “modern” methods have become, in many cases, much faster and easier to use than the traditional methods due to modern machines and equipment. This separation is an attempt to allow a potential gallery submission to be judged against other work on a more equal footing than is practical with a single overall category. Though not always true, some of the traditional methods require more skill and time to accomplish a finished result than by using more modern methods.

Does this mean you can’t use your Baldor grinder with a wire wheel to clean up your hand forged gothic grille? No it is not meant to restrict time saving methods that don’t really impact the nature of the finished piece and are really a faster equivalent version of the traditional “by-hand” method. It does mean you can’t arc weld that one piece that broke off from a stress crack at the last minute and try to hide it with judicious grinding and reheating to cover the tracks with fire scale if you want to enter the piece as “traditional.” Can’t people cheat? Possibly. We are betting most won’t. Will there be judgment calls or “gray areas” in what to call traditional? Probably. If there are any issues that come up, the Board of Directors will make a judgment on how to place the piece in the Gallery. Mostly, any benefit of the doubt will go to the entrant.

General Gallery:

We would also like to see a general gallery of work from all levels on display. It does not have to be all new work or work submitted for the People’s Choice voting. It can be for sale or just for display. But we would like to have anything you are proud of to be on display. Even work by beginners is often an inspiration so please don’t hold back thinking your work is “not good enough.” Keep in mind, there will be visitors that have never even forged an S-Hook or a leaf key chain. Any work probably has something to teach and inspire others. Please consider bringing your items to display! - *Editor*

Iron in the Hat

Gerald Franklin

Many of our newer members were confused at last year's conference as to what this "Iron in the Hat" (IITH) thing was all about. Since I have been appointed as the IITH coordinator for the conference, I guess it's one of my duties to explain the tradition and how we observe it at our conferences.

The Iron in the Hat activity is an old blacksmithing tradition (exactly how old is anybody's guess) that makes a little money for the sponsoring organization and provides an outlet for some of the things that an individual smith may not need anymore but another smith may "covet". Basically it's a raffle of sorts where items are donated, tickets are sold and drawn and the items then change owners.

Here's how it works at the Saltfork Conference. Members, merchants, and just good people donate items. We put the items out for display with a paper sack beside each item. Tickets are sold and buyers put one or more tickets into a sack corresponding to an item they are interested in. If you would really like to have a particular item, put several tickets into the sack. At a particular time a winning ticket is drawn from a sack and then taped to the item. Buyers then come by and check the tickets to see if they are a lucky winner. This is pretty simple, and there will be more information posted at the conference as to price, frequency of drawings, etc.

So, what makes it work? The short answer is "item donors and ticket buyers". You can help in both ways. Bring stuff to the conference to donate to the IITH table. This may be a piece of tool steel that you don't need, an extra pair of tongs (I know, NOBODY has an extra pair of tongs), supplies such as flux, rivets, old files, new files, etc. When you go to the hardware store and you see a set of screwdrivers, for example, on sale at a ridiculously low price, buy it and bring it to the conference for IITH. I have already had folks drop donations off with me so it's not too early to think about what you want to donate. Each year I manage to bring a few things and I used to wonder what would be appropriate. It finally hit me that if I would be interested in a certain item, chances are somebody else would be interested in it, too. So now when I'm standing at the bargain bin at Harbor Freight, I buy things that I'd like to have. Simple stuff like epoxy, sandpaper, soapstone, steel tapes, etc are always welcome.

So, we've talked about donors. The other part of the deal that makes it work is buyers. Even if you show up at the conference without anything to donate to IITH, you can buy tickets. They will be on sale by several sellers. You can't win if you don't play.

Not everybody who comes to the conference brings donations. Not everybody who comes buys tickets. Not everybody who buys tickets wins something but every little bit helps raise a buck for the association. It's not cheap to put on a conference and we've managed to keep registration fees low for many years. Think about this: if 100 conference attendees buy \$10 worth of IITH tickets, that's \$1000 that can go a long way toward paying for demonstrators, travel, materials, etc.

(This article is being repeated by request from the August 2018 Newsletter - Editor)

2019 SCABA Conference Tool Box

Bruce Willenberg has volunteered again this year to keep track of the tools until the Conference. Any donated tool is greatly appreciated as proceeds from this drawing benefit the Saltfork club as a whole but hand made tools are the most appreciated by those interested in winning the box. Either way, the winner of the tool box drawing will have a nice collection of usable tools that they will be proud to own.

From Bruce:

Here is a suggested list of tools for the 2019 conference tool box. We are hoping to have as many Smith made tools as possible but we'll take store bought too. Items checked off are tools that are actually here.

UPDATE: So far the only tool I have collected is a handled square punch. I have heard rumors about other tools out there but as of yet.....

I certainly hope we are going to have a bunch show up soon or is going to be a very light tool box.

Please don't put off till last minute your donation. The more tools we have in the tool box, the more tickets we sell, and the more money the club makes. Don't put it off, gather your either shop made tool or store bought tools.

- Keep hammering, Bruce

You got questions or comments phone or text at 405-227-4547

brskw1976@yahoo.com

Tickets for a chance to win the box will be available up until the drawing at the auction on Saturday night. If you will not be able to attend the conference and want a chance to win the tool box while supporting the club, tickets may be purchased from the Secretary. Tickets are \$2.00 each.

Suggested Items	Donated
Ball peen hammer	
Cross peen hammer	
Rounding hammer	
Hot slit chisel	
Handled hot cut chisel	
File, flat bastard cut	
File, half-round bastard cut	
Farrier's rasp	
Hacksaw	
Rivet backing and setting tools	
Scribe	
Center Punch	
Center Finder	
Dividers	
Tongs	
1/4 V-bit	
3/8 V-bit	
1/2 V-bit	
Punch, Square with handle	X
Punch, round	
Punch/Chisel set with tongs	
Scroll pliers	
Soapstone and holder	
Abrasive block, small piece of grinding wheel	
Chisel, large	
Chisel, small	
Metal ruler	
Ball tool (round blunt nose punch)	
Hand held spring swage for tenons	
Hand held swage for necking down	
Set of monkey tools (1/8", 3/16", 1/4")	
Bending forks	
Dog Wrenches	
Flux and flux spoon	
Twisting wrench	
Hot cut hardy	
Bolster plate	
Finish wax	
Shovel	
Rake	
Poker	
Water can	
Multi Square	
Nail Header	
Flatter	
Wire Brush	
Hold Fast	

Peter Ross

“ My experience studying historic ironwork has kept me interested in using hand methods and solid basic hand skills. I prefer this to making jigs and elaborate tooling, and can generally make most pieces using just my standard cross pein hammer and a few pairs of standard tongs. To me this is much more satisfying and more engaging, and I like the results much better too! “

I got my start in Blacksmithing at the age of 17 when I took a class at a local museum (it was taught by Steve Kayne). We learned to make a simple hook the first night, and on subsequent nights made many more. After a few months of working in a homemade forge in the garage I began volunteering at a nearby historic village. There was a real shop and an older man who knew the basics. We made hardware, fireplace tools, and farming tools for the village using antiques as models. The pieces immediately got a thorough testing by the other staff, which helped me get over the romance of creating something by hand.



After a couple of years at art school, I worked a year for a smith named Dick Everett in East Haddam, CT. We made museum quality reproduction hardware for historic buildings and repaired antique ironwork. Dick gave me a big push towards understanding old ironwork. After that, I opened my own shop on Deer Isle, ME. where I worked for 4 years.

In 1979, I moved to VA to join the blacksmith shop at Colonial Williamsburg. Two years later I was promoted to Master of the shop. My job entailed producing hundreds of articles for the ongoing restoration and museum programs while trying to re-develop 18th century methods in a historic setting. I also trained a number of apprentices. It was this combination of goals that gave me the greatest insights into hand work and the environment of hand technology. These have shaped my aesthetics and thoughts about the role of the craftsman in modern society.

In 2004 I moved to North Carolina and again opened my own shop. Since then I have been busy making reproductions of antique hardware for historic buildings, both private homes as well as those open to the public.

Over the years I have been a frequent demonstrator at local and national blacksmith conferences, and have taught many classes at various schools.



Ken and MaryLou Zitur

Ken's career as a blacksmith began in 1974 at the Burlington Northern Railroad in Waite Park, Minnesota. It was here he completed a four-year apprenticeship and received a diploma from Railway Educational Bureau. Ken worked in the blacksmith shop until the railroad closed in 1986. During Ken's 12 years at the railroad, he also had the opportunity to work with Paul Hubler, a prominent blacksmith from Rockford, Minnesota. Paul shared his love of blacksmithing with Ken and taught him so much about the decorative aspect of blacksmithing.

In 1988 Ken took his love of metal work and began his own business, naming it Ken's Custom Iron. One year later, his wife MaryLou joined the business. For nearly 20 years they traveled to as many as 20 art and craft shows per year in the Upper Midwest and Arizona selling their wares. During this time, they were also making railings for high-end homes along with fireplace surrounds, screens, and tools, and restoration work. In the 90's they began making store fixtures for five companies to include display tables, banner holders, and retail risers and shelving. Some of their work has been in the Smithsonian Institution, Macy's Department Store in New York, Saks Fifth Avenue, several casinos in Las Vegas, the Denver Airport, Nordstrom, Herberger's, Best Buy, Aveda, Dayton's, and Harold's. The store fixture work lasted for about 10 years and led to them doing some industrial forging and fabricating for several companies. At this time, Ken also did some part-time teaching in the welding department at a nearby college.

In 2015, the smaller version of the KZ100 Power Hammer, the MZ75 Power Hammer, was introduced. Along with the well-known "Quick Tongs" and other blacksmithing items featured in their online store, the MZ75 Power Hammers have now taken the main focus of the Ken's Custom Iron team. Taking these products and traveling to blacksmith conferences throughout the states in recent years has been a very rewarding experience.

During the winter months Ken teaches weekend blacksmithing classes in which students learn the craft. The class topics range from beginning and intermediate level blacksmithing skills, hammer-making, tong-making, tool-making (punches, chisels, tongs), heat treating, animal head making, and many others.

What started as a one-man shop is now so much more. Ken and MaryLou are blessed to have such a great team. They have their daughter, son-in-law, and grandson joining them in the business along with two other employees. Samantha, their daughter, handles many of the office-related duties: customer service, marketing, graphic design, videography/photography, and more. Justin, their son-in-law, is the lead welder and assembler of the MZ75 Power Hammers. And this couldn't all be accomplished without the help of their Office Manager and toddler grandson, Blake.



Conference Demonstration and Workshop Plan:

Like any live event, the plan for demonstrations and workshops is always subject to change depending on how everything actually goes at the Conference. But this is an idea of what you can expect this year:

Peter Ross Demo:

Peter has planned to demonstrate the making of a colonial style hacksaw frame including the smaller parts that complete the saw. If time permits, Peter will demonstrate box joint pliers (the after-conference workshop project.)

Peter Ross After-Conference Workshop:

The project will be forging colonial style box joint pliers. This will be a smith/striker project so that workshop participants will pair up to strike for each other as required on the project. This is a simple project to understand once you see it demonstrated but has many challenges to properly execute. Participants should plan on making several attempts to forge each half of the pliers to fully develop the skills needed to complete good work. (For a preview of this type of project refer to page 29 in this newsletter for an article from the California Blacksmith Association and the January 2016 Saltfork newsletter, page 26, for an article showing a Peter Ross demo from the Alex Bealer Blacksmith Association.)

Ken Zitur Demo:

Ken has 8 different power hammer demonstrations that he will be doing at the conference. Those items are a chain hook, an anvil on a stick, a pair of tongs using progressive tooling, a decorative strap hinge, a one piece flower, a hardy bending fork, a hand held bending fork, and a hand hammer. He will explain how to make the tooling, how to use the tooling, and show how the tooling can make you more efficient under the power hammer.

Ken and MaryLou will be doing some team striking demos making a heart hook, a split candle holder, tongs with forge welded reins, and more if time allows.

Ken Zitur After-Conference Workshop:

Ken Zitur has been blacksmithing for around 45 years. He will be taking his knowledge of metalwork and power hammer skills and will be teaching a 3 day hammer class at the Saltfork Conference 2019. Using a power hammer the students will be making all the tools necessary to make a hand hammer and will finish the class by making a 2 lb hand hammer.

This will include heating, uncoiling and straightening 2 large springs. The material from the springs will be forged into hand hammer eye drifts. We will make a bottom swage and then use that swage to make a flatter to be used in forging the peen of the hand hammer under the power hammer. Ken will also show 3 styles of handles for this tooling. Students will be making and welding these handles to the tooling. A pair of tongs for working under the power hammer will also be made using Quick Tong blanks.

Using a power hammer, the students will then forge a 2lb. hammer, grind to shape, heat treat and fit the handle.



KEN'S CUSTOM IRON
37634 County Road 9, Avon, MN 56310
320-746-8161 - mail@kensiron.com

TRY THE MZ75 POWER HAMMER AT THE 2019 SCABA CONFERENCE!

Along with our Quick and Rapid Tongs, tooling, accessories, and blacksmithing apparel, we will be bringing the MZ75 Power Hammer to this year's conference. We welcome you to join us to grab your favorite products, try the MZ75, or watch Ken and MaryLou as conference demonstrators on Saturday and Sunday.

You can also save up to \$600 in shipping costs by taking an MZ75 Power Hammer home with you from the conference. (We will only have one MZ75 available at the conference, so make your plans today!) Contact us for more information!



WWW.KENSIRON.COM





PLEASE HELP!!

OKLAHOMA STATE FAIR DEMONSTRATORS NEEDED

Saltfork Club members.... WE NEED YOU!!!!

The Oklahoma State Fair is here this month. We still need demonstrators. Saltfork receives a payment for this event that helps with club expenses and programs throughout the year. If you would be interested in signing up, please let me know as soon as possible.

The OK State Fair will run:

Thursday, September 12 through Sunday September 22, 2019.

The weather forecast I saw looks to be high 80's low 90's this year. Who knows about the rain chances though..... We are seeking those who would like to help promote and talk about the club by demonstrating to fairgoers. You may bring any items you may have made throughout the year and set them on the table to sell.

Those demonstrating will be given a gate and parking pass. In years past we have also had a complimentary hotel for those traveling the greatest distance from out of town. Consideration is given on a first requested and distance traveled consideration.

If you would like more information about this fun event, please contact:

Richard Blasius 405-881-0804 or his wife Michele 405-550-9850.

Box Joint Pliers

Demonstration by Gary Brown

CBA Spring Conference 2014



Side View

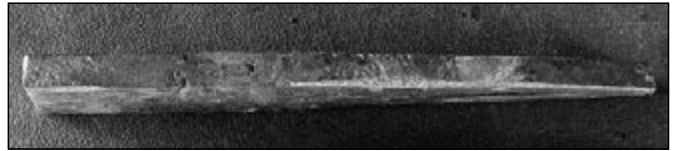

Top View



This is an example of a process to make precision-fit-tools using imprecise tools and processes.

Some points to pay attention to:

1. Maintain the centerline carefully.
2. The box joint is diamond-shaped, not square.
Its length is your choice. A golden mean ratio looks nice.
3. The diamond angles are not 45°. (*see drawing*)

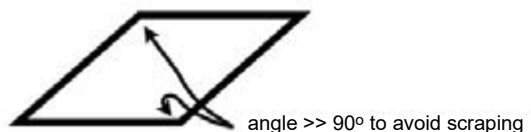

The start is similar to making tongs, but the boss area needs to be thicker for the female part.

Stock

1/2" x 3/4". Start with a long piece ~10" so that you can cut off the extra later, but have a handle while making the joint. You can scale this up or down. Gary feels that the smaller size is more difficult.

Female Part

Fuller in about a third of the way across the stock, as shown.

Flatten sides. Let it cool, then mark (cold) for punching. Mark the corners, making sure that the line is centered. Mark the end of the punch line with a center punch. Use a cold chisel to mark the corners and the punch line, making sure that the line is centered.

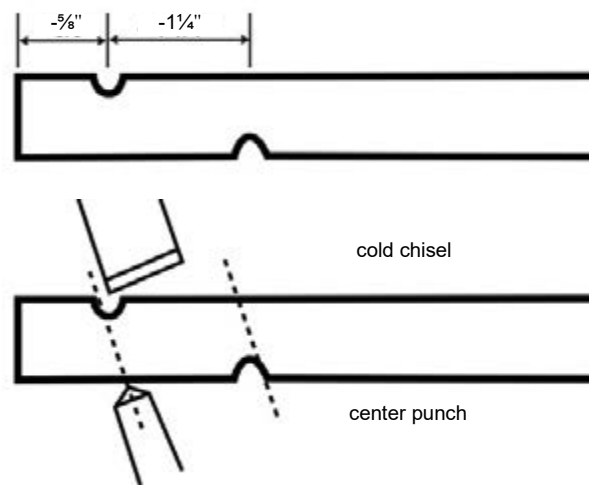

Box Joint Pliers

Then slit punch, using a slit punch that is sorta sharp. Do this at a high heat – you'll lose less metal that way. Slit at an angle – work from both sides, trying to meet in the middle.

You want the hole about $\frac{1}{8}$ " undersized, because you'll drift it next.

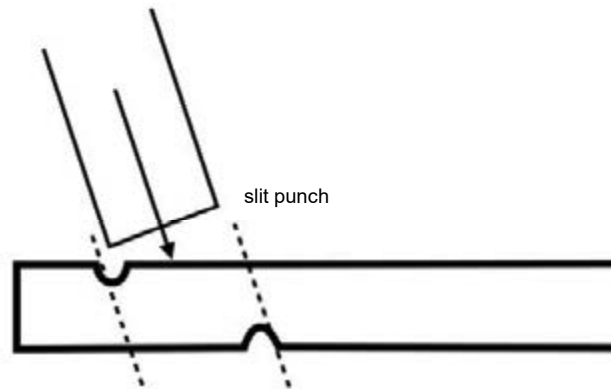

Gary then made a drift out of $\frac{1}{4} \times 1$ mild steel. He used this to drift the box hole. He also had to do a bit of hammering on the sides with the drift in place, to clean up the sides. Draw out the jaw and the handle (rein).



Male Part

First, make a step tool to help this process along. The min size section is the start width. The max size section is the finish width. Also make a matching square top tool piece.

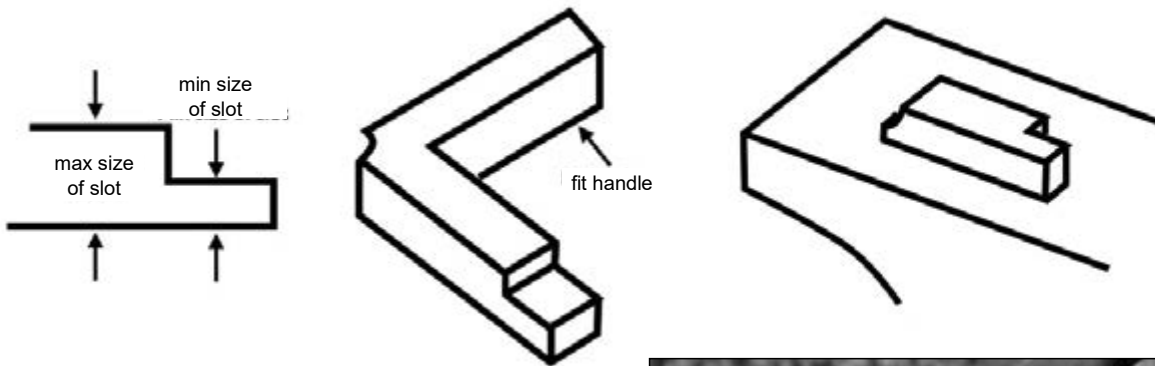

Here's how you'll use it:

The top tool is a matching rectangular bar.



Box Joint Pliers

Forge the male part at a good yellow heat to get sharp corners. If you get too much distortion, switch to a rasp or file to bring to desired size/shape.

Fuller a third of way across, the stock, a little closer together than for female part.

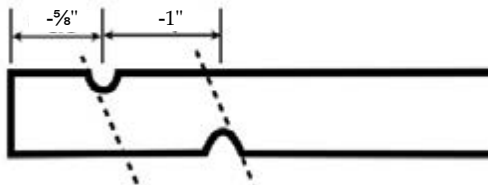

Spread using the Hardy tool and matching top tool as square-cornered fullers.



The thinned section will stretch when you forge it back in.

Now, being careful not to destroy the necked-down part, draw out the ends to form the front and back of the joint.

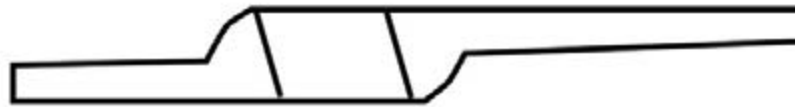

Cut off 3" to 4" back, and draw out the handles.

Going back to the female part, draw out the front and back, and then cut off the same distance back and draw out the handle. Be careful, the tricky part is to avoid collapsing the eye. If necessary, correct the eye with your drift.

You don't want too close a fit, as we will forge the pieces to match.

Gary made the handles half-round, using a half-round bottom fuller.

This was the end of the first day of Gary's demo. He put it together the next morning.



Box Joint Pliers

Assembly

Align the pieces so that the centerline through the box matches the centerline of the jaw and leg.
Note the sections that must clear the centerline.

In a nutshell, here's the process:

- Open the female jaw with the drift.
- Slide the male part through.
- Hammer down to match.

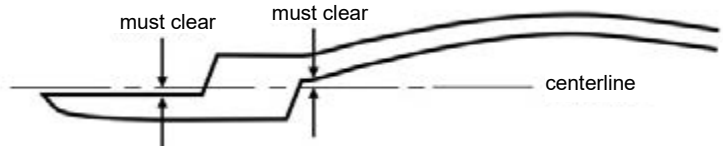

To spread the female part of the joint, use the drift with the female part warm, not super-hot.

You do not want to stretch the material, just move it out of your way.

Go slowly, using several heats.

Once it is open enough, slip the male part through.

Heat both pieces, and hammer the jaws and legs closed.

Next, flatten and remove any bulges.

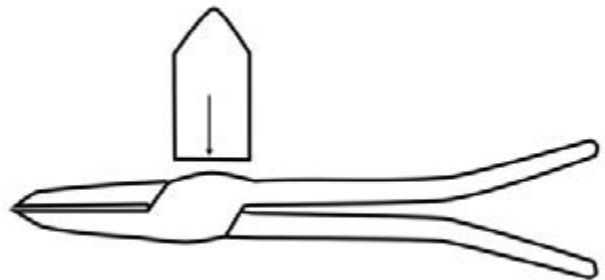
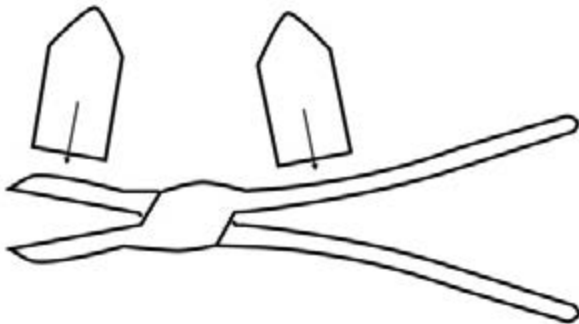

Hammer the jaw section back to rectangular, and then even up the jaws and handles. You want the pieces to just fit, to be a slightly tight fit.

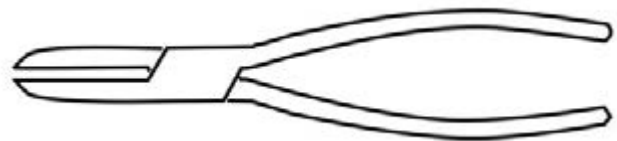
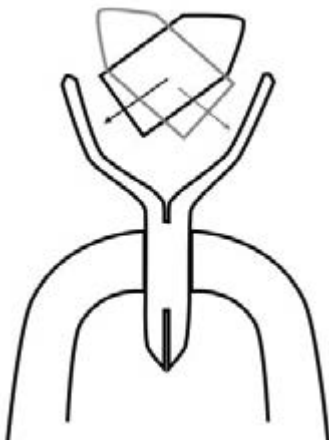

Go to the vise, bend out the legs, and then re-heat and curve.

Open and close to check the action. Drill, countersink the hole, rivet and file.

Enjoy and admire! ♣

Copper Tulip

By David W. Wilson

This tulip is planished from .032" (20 gauge) copper. The end of a fireplace poker handle will work well as a stake. A smooth face planishing hammer will not leave unwanted marks on copper. To make the copper easier to work, frequently anneal it, especially after hammering. To anneal, simply heat with propane torch to dark red and quench. The PETAL Patterns are designed to conserve material. Individual petals may also be created, however the inner petals should be slightly smaller.

A stem may be made from 1/4" round stock. Use oxyactelene torch to weld a nut on the stem for shoulder (at base of petals). Heat and hammer the hex nut to a round shape. Inside the petals, a threaded end with nut on the stem will allow easy repositioning and removal of the petals. Peening over the stem onto the petals will also work. Put a slight curve in the stem to add a realistic look.

The leaves are made from 22 gauge sheet steel. Fold the LEAF Pattern in half and open half way. This creates a center vein for the leaf. Ridges are made by heating with propane torch and bending with smooth needle nose pliers. File or snip the tips so they are not sharp. Wrap the base of the top most petal onto the stem first. Then wrap the lower petal base around the upper one. Note: the lower petal has a longer base to hide the upper petal base.

I believe the author means to wrap the "leaves" around the stem here. - Editor

To make a ridge on the center of the petals, use copper wire. Wrap the wire around a round surface, lay

the petal on the wire, outside up. Hammer with dead blow hammer to raise ridge.



Drill 1/4" holes in the copper PETAL Pattern. Place the larger, outer petals on the stem first, then the inner ones. Screw nut onto the end of the stem, stagger petals as

Created by David W. Wilson
Illustration/Design <http://www.flash.net/~dwwilson/>
Mail to dwwilson@flash.net

This article is reprinted courtesy of the Central Virginia Blacksmith Guild newsletter May 2019.

See Following Page for Leaf and Petal Patterns.

AABA WINTERFEST III



JAN 23-25, 2020

PIMA COUNTY FAIRGROUNDS, TUSCON AZ

CAMPING • FULL RV SITES • BANQUET •
GALLERY • SILENT AUCTION • LITTLE TENT EVENT
EDUCATION TENT (NEW)

DEMONSTRATOR LIST

Jack Brubaker, Rodger "Grizz" LaBrash, Doug Pryor, Ellen Durkin
Little Tent Event: Fred Zweig Education Tent: Jaime Escobido

FOR REGISTRATION AND MORE DETAILS VISIT: AZBLACKSMITHS.ORG



Leaf and Petal Patterns for the Copper Tulip project. (See previous page.)

This article is reprinted courtesy of the Central Virginia Blacksmith Guild newsletter May 2019.

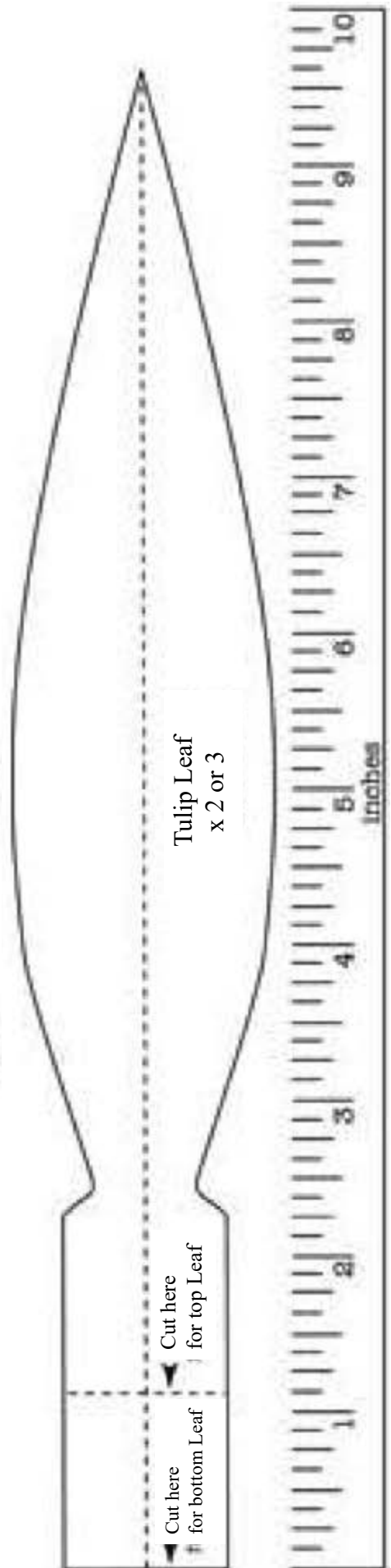
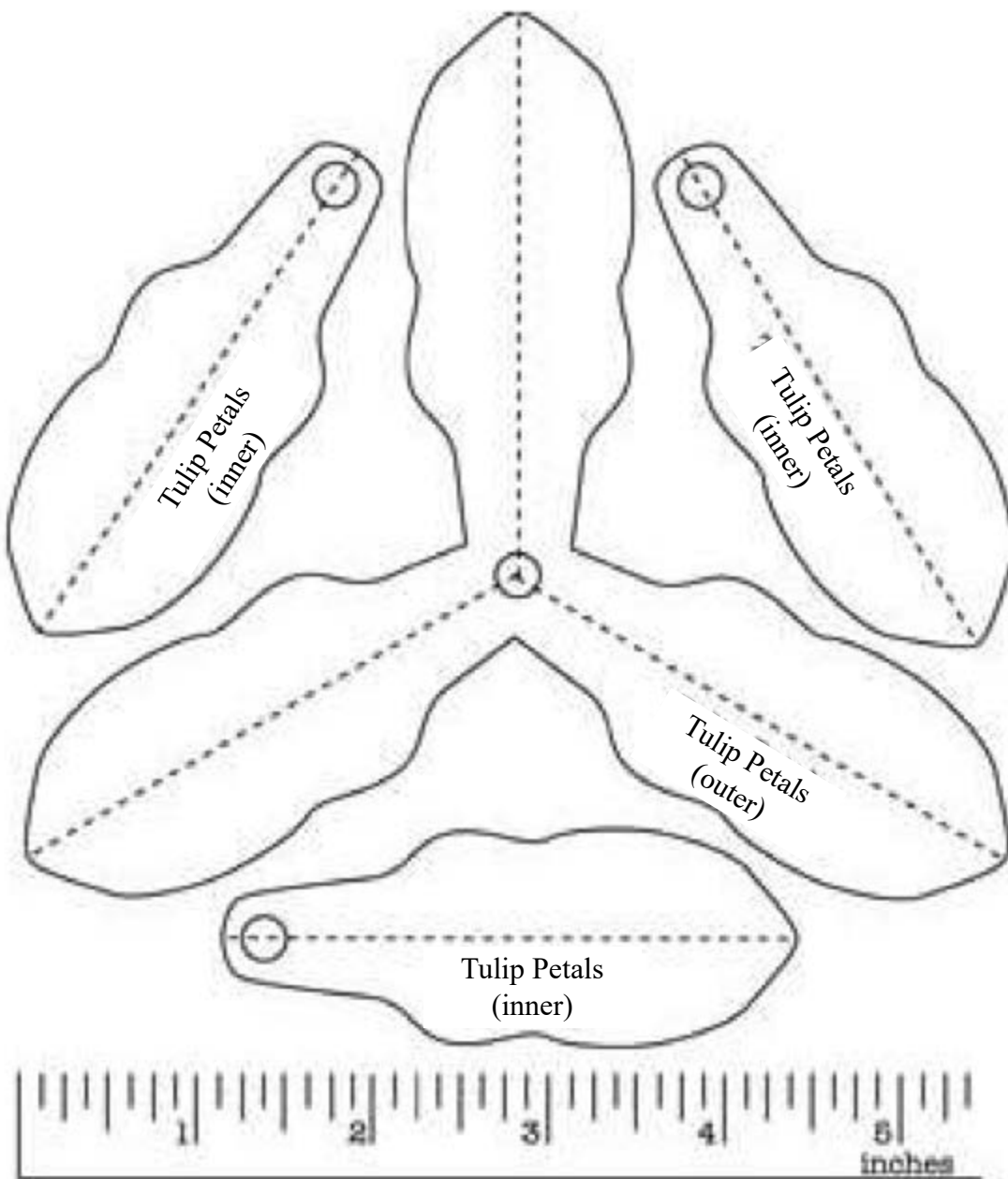

Dances with Tongs

Loosening Sticky Tongs

Technique Taught by Erin Simmons at Hard Rock 2018

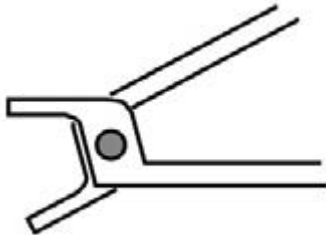

Let's say your tongs stick here, but it looks like there's plenty of travel and flat bearing surface beyond the sticky point.

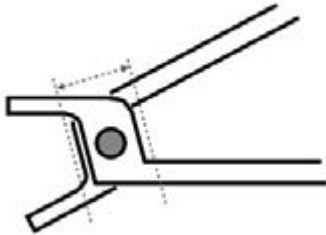

First, heat this area *in the stuck position.*



Holding the reins in the stuck position, tap gently and rapidly on the anvil, tapping on both reins. This will usually work to loosen up the stuck joint. You should be able to reach smooth travel over the full operating range.

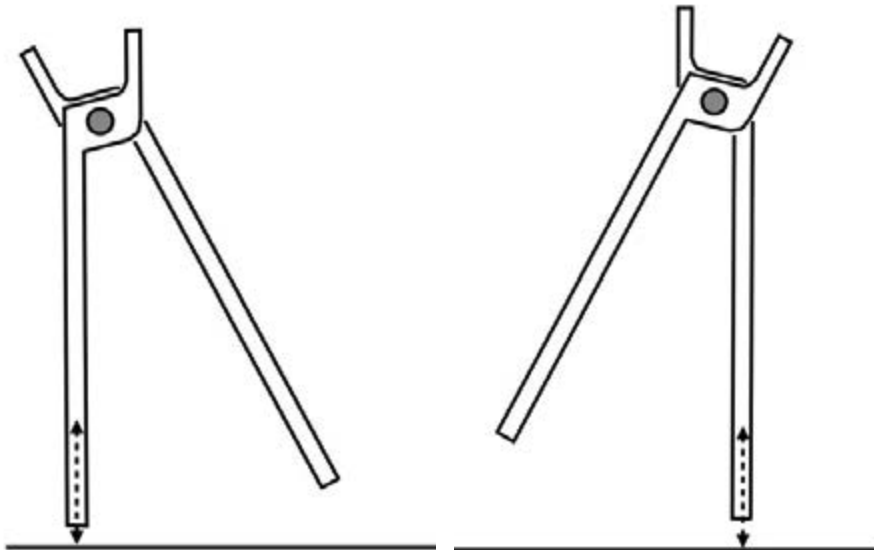

Had as many problems as I have with sticky tongs? Since learning this technique from Erin, I have used it repeatedly. I would have held this for a much later edition, but it has been so useful to me that I felt that it needed to be shared now. ~ Editor

Ted's Garden, Part 1: The Trumpet Flower

by Ted Banning



Materials Required

- At least a foot of 1/4" round
- A couple feet of 3/4" black pipe, although smaller is ok
- A fullering tool , also called a guillotine tool
- Hacksaw or bandsaw



Fullering Tool

The Stem

- Take the 1/4" round and taper the end , tapering about 4 inches
- Bend the tapered portion gently back and forth in a zig zag
- Using the fullering tool , forge a small groove right at the 4 inch mark, the whole circumference of the stem. Don't go too deep

The Blossom

- Take the pipe and use the fullering tool to forge a groove about 3 inches from the end. Take care not to pinch the pipe too much, checking periodically with the 1/4" rod for a snug fit
- Using the hacksaw, make two 2 inch cuts lengthwise on the end of pipe just fullered.



- On the horn of the anvil curl the two petals open almost half way
- Cut the blossom off the pipe below the groove about 3/4"

Assembly

- Slide the blossom on the stem, big end first.
- Align the groove on the stem with the groove on the blossom
- Using the fullering tool, crimp the blossom onto the stem until it stays.



Tips

- Add some life to the stem with a couple bends
- Never quench pipe, it becomes a steam cannon
- Add a metal or wood base
- Apply wax or paint

Ted Banning is Vice-President of CVBG, and a highly regarded smith, hammer builder, philosopher and teacher. This is the first of a series of articles on botanical forging.

This article is reprinted courtesy of the Central Virginia Blacksmith Guild newsletter May 2019.

Need a new smithing apron or leather tool roll?

Look for T-Star Leather at the 2019 Saltfork Conference
in the vendors area...





ABANA 2020 Conference



ABANA 2020 Conference

Washington County Fairgrounds
392 Old Schuylerville Rd.
Greenwich, NY

Information Available at

www.abana2020.com
abana2020 on facebook
abana.org
ABANA Central Office
423-913-1022

We will be featuring 8 disciplines of Smithing with at least three talented Smiths in each.

ART: with Daniel Miller, Zeevick Gotleib, & Ellen Durkan

Historic: with Peter Ross, Dick Sargent, & Bob Valentine

TOOLS: with Patrick Quinn, Jeffery Funk, & Eric Schatzel

KNIVES: with Matt Parkinson, Lin Rhea, & Jeff Helm

POWER: with Bruce Jarrell, Steve Parker, & Randy McDaniel

FARRIERS: with Dave Farley, Roy Bloom, Tom Willoughby

TEACHING: with Mark Aspery, Gerald Boggs, & Randy Augsburger

FARM: with Joel Tripp, Judson Yaggy, Derick Glaser, & Lucian Avery

The Patient Order of Meticulous Metalsmiths with Tom Latane, Peter Renzetti, Carl Close & other exceptional craftsmen.

The lecture series will be featuring such notables such as Albert Paley, Howard Schechter, Doug Wilson, Bill Hochella, Leigh Morrell & members of the demonstrator staff.

There will be a youth teaching venue and family programs for the non blacksmiths.

The raffle will include a BAM box donated by Pat McCarty and a Big Blue power hammer.

The Iron in the Hat is pleased to announce the return of Len Ledet with his special blend of entertainment and wackiness.

The Saturday evening banquet is back with a New England style BBQ.

We will have a beer tent serving a local micro brew and a local distiller will be pouring our own signature Slack Tub bourbon. Collectable laser inscribed 2 liter wood casks can be purchased filled with our special label. See the website for information on the cask which can only be pre ordered and can only be picked up at the conference.

Early registration is now open at :

abana2020.com



**Follow us on facebook:
[ABANA 2020 Conference](https://www.facebook.com/ABANA2020Conference)**

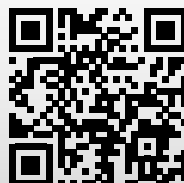



ABANA 2020 Conference

Washington County Fairgrounds
392 Old Schuylerville Rd.
Greenwich, NY

Information Available at

www.abana2020.com
abana2020 on facebook
abana.org
ABANA Central Office
423-913-1022



Scheduled Activities

Demonstrations all day every day at our 8 demo sites. There will be a riveting lecture series featuring such notables such as Albert Paley, Howard Schechter, Douglas Wilson, Bill Hochella, Leigh Morrell, and others

Join the party at the Blacksmith Arms Pub serving local micro brews. We are proud to announce our own private label Slacktub Bourbon. Available by the glass, bottle or collectable 2 liter wooden cask. See the website for information on pre ordering the laser inscribed cask. These must be pre-ordered.

Breakfast, Lunch, Dinner will be available onsite from a variety of food vendors and food trucks.

There will be extensive tailgating, most under roofs. The northeast is the epicenter of the largest accumulation of blacksmithing equipment in the country. If you can dream of it, it will likely be at this conference

We are inviting all the vendors we have come to expect at an ABANA conference.

There will be nightly competitions organized by Mark Aspery to be held at the Teaching site

Of course there will be Iron in the Hat hosted by Len Ledet. We also will be having a large item raffle featuring a Big Blu power hammer and Pat McCarty is donating a BAM box once again for this event. An added bonus will be it is going to be filled with handmade tools from some of the finest blacksmiths in the country.

We are hoping for a strong outpouring of support for the curated gallery exhibition and hope to have items donated to the live auction of art & craft scheduled for Saturday night.

For this conference the banquet will be revived with a Saturday night BBQ northeast style, included with registration. Come and enjoy the warmth and fellowship of blacksmiths from around the world. This will be a party the likes of which has not been enjoyed at an ABANA conference in some time.

Don't miss what is sure to be an event that will be talked about for years.

SCABA Shop and Swap

**** NEW ****

For Sale:

Buffalo Forge Co. Bomb Shelter Blowers:

Located in Panama City, Florida these are Hurricane Michael survivors. NOS, stored since early 1980's, both work and will need lubrication before actual use. (Additional info on next page.)

If interested contact James Kirkland by e-mail to:
jlkclk@sbcglobal.net.



SCABA Shop and Swap

Printed in U. S. A.

SUGGESTED FILTER INSTALLATION FOR *Buffalo* #1 CD BOMB SHELTER VENTILATOR

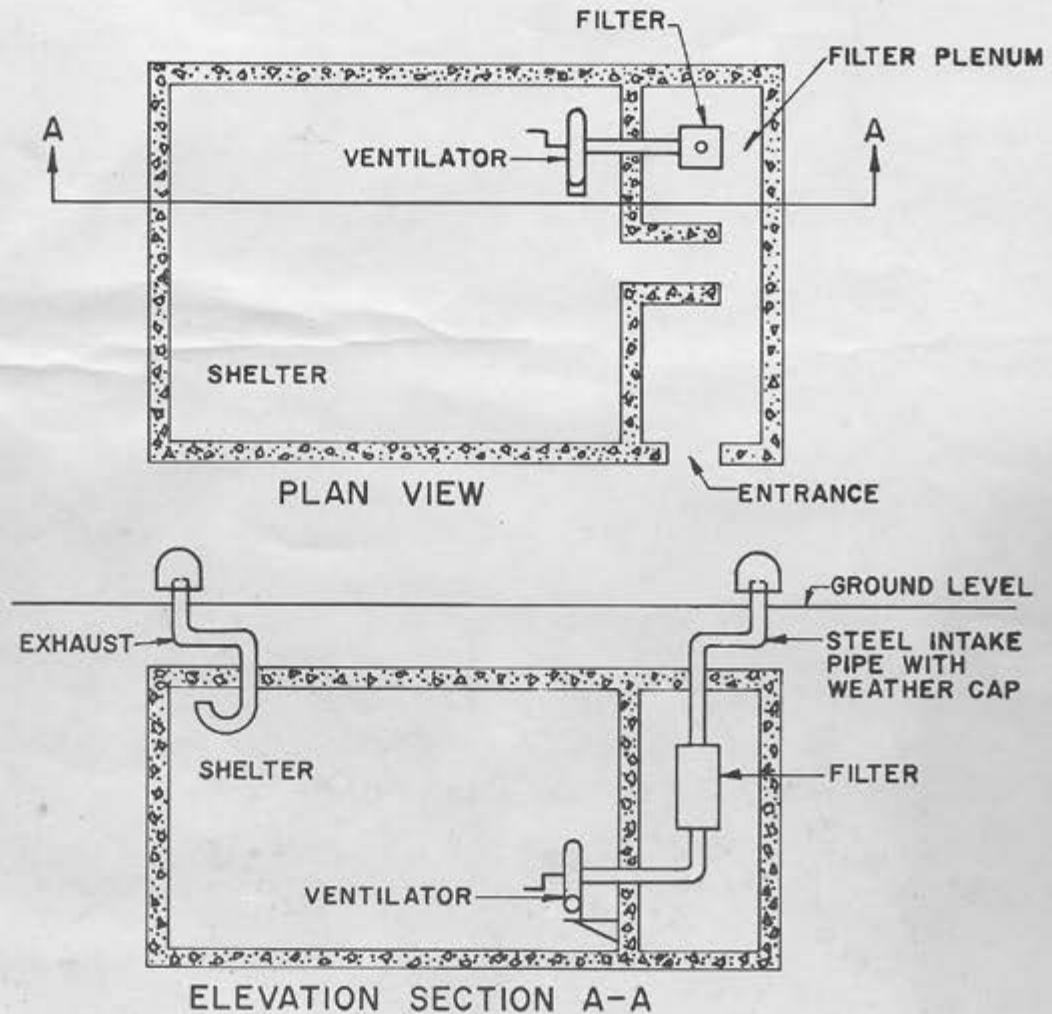

FILTER IS LOCATED IN PLENUM CHAMBER SO THAT BLAST WILL NOT HARM IT. FILTER MUST BE LOCATED OUTSIDE OF SHELTER ROOM AND HAVE AT LEAST ONE RIGHT ANGLE BEND IN THE DUCT LEADING TO THE BLOWER. THIS ANGLE BEND MUST BE OUTSIDE OF THE SHELTER ROOM IN ORDER TO KEEP RADIATION, WHICH TRAVELS IN A STRAIGHT LINE, FROM COMING DOWN THE DUCT FROM THE FILTER (WHERE THE RADIOACTIVE PARTICLES ARE TRAPPED) INTO THE SHELTER ROOM. AMPLE SHIELDING MUST BE USED IN THE WALL BETWEEN THE PLENUM CHAMBER AND SHELTER ROOM.

BUFFALO FORGE CO. BUFFALO, N.Y., U.S.A.

2W-48656

SCABA Shop and Swap

175 Lb Hay Budden Anvil

Good Condition. \$700.00
Contact: Mark Carter 405-613-5215



For Sale: 15 Lb Tire Hammers:

\$1,200 for everything from the base plate up. Two rounding dies included as standard. Has 1/2 HP 115V Motor. Contact: David Barfield - 580-595-1476



SCABA Shop and Swap

GET AN APRON THAT FITS YOU AND YOUR NEEDS

FORGE-APRONS.COM

KAYNE & Son -- **Blacksmiths Depot**
 Custom Hardware, Inc.

100 Daniel Ridge Rd. Candler, N.C. 28715
 828-667-8868 fax 828-665-8303

Steve Kayne

- Tools for the Metalworker
- Hammers & Tongs
- Spring Swages & Texture tools
- Anvils, Vices, Slakes and Hardy tools
- Books & Videos
- Specialty Fasteners
- Blacksmithing
- Custom Hinges and Handles
- Thumb latch sets & Lock sets
- Exterior/Interior Hardware
- Builders/Architectural Hardware

BlacksmithsDepot.com - CustomForgedHardware.com



Ken's Custom Iron, LLC

37634 County Road 9
 Avon, MN 56310
 (320) 746-8161
mail@kensiron.com

Blacksmith Supply
 Modern Tool For the Modern Blacksmith
www.blacksmithsupply.com

John Elliott

jelliott@blacksmithsupply.com
 804-530-0290

P.O. Box
 Chester, VA 23831



Blacksmithsupply.com

Raker Knives & Steel
Ray Kirk ABS-MS



www.rakerknives.com
gadugiblade@yahoo.com

918-207-8076
 Tahlequah, Ok

T STAR LEATHER

Brett Smith
 310 E. Fry Terrace
 Claremore, OK 74017
 410-251-4463
tstarleather@gmail.com
www.TStarLeather.com

Fine Hand Crafted Leather Work
 Craftsmanship, Detail, Creativity, Excellence

"T Star Smith"
 SASS #72768

SCABA Shop and Swap



Call to Order Toll Free 24/7 - 866-627-6922

Thank you to our Conference Vendors who graciously donated items for the Conference Auctions!

Their contributions helped to support SCABA. Please consider patronizing these vendors to return the favor!



Reeder Products Inc.

3201 Skylane Drive, Suite 114
Carrollton, Texas 75006 United States
(469) 257-1000

Bill Davis Forge Welded Tomahawk DVD

This DVD is now available to members for a minimal cost (cost of DVD's is minimal to cover reproduction and shipping if applicable.) Contact the SCABA Librarian, Don Garner, if you would like to get a copy of this DVD.

Don Garner: 580-302-1845

(Call or Text. If you get voice mail, Please leave a message.)



For Sale:

Tire Hammer Plans by Clay Spencer

Send a check or money order for \$30 US to Clay Spencer, 73 Penniston Pvt. Drive, Somerville, AL 35670-7013. Or send \$32 US to Paypal.Me/ClaySpencer. E-mail me at clay@otelco.net. PDFs will be e-mailed outside US. Phone 256-558-3658

Beverly shear blades sharpened

Remove your blades and send in USPS small flat rate box with check for \$41 US to 73 Penniston Pvt. Drive, Somerville, AL 35670-7103.

For Sale: I have numerous old tools and collectible items of various kinds including blacksmith related tools and equipment. Too many tools to list them all. Inventory is always changing. Contact: Craig Guy (SCABA Member), Piedmont, OK
Cell Phone: 405-630-7769 (Call or Text)

SCABA Shop and Swap

SCABA Library DVD's Available:

This is a partial list of the DVD titles available to members from the SCABA Library. Contact the Librarian (Don Garner) if you would like to obtain a copy of any listed title or if you have questions on any other titles that may be available. Additional titles are listed on the website. DVD's are available for a very minimal cost to offset the blank disc and cases or sleeves. Shipping cost applies if you need these delivered by mail.

- Robb Gunter Basic Blacksmithing parts 1,2,3 and the controlled hand forging series
- Clay Spencer SCABA conf.2013 pts. 1,2 and 3
- Jerry Darnell 18th century lighting, door latches and hinges
- Brent Baily SCABA conf. 2011
- Mark Aspery SCABA conf. 2011
- Robb Gunter SCABA conf. 1998
- Robb, Brad and Chad Gunter 2009 joinery, forging, repousse, scrollwork, etc.
- Bill Bastas SCABA 2002 pts. 1 - 6
- Jim Keith SCABA conf.2007
- Power hammer forging with Clifton Ralph pts. 1 - 5
- Doug Merkel SCABA 2001
- Bob Alexander SCABA 2008
- A. Finn SCABA 2008
- Bob Patrick SCABA 2004
- Gordon Williams SCABA 2010
- Daryl Nelson SCABA 2010
- Jim and Kathleen Poor SCABA 2001
- Ed and Brian Brazeal SCABA 2006
- Ray Kirk Knives SCABA 2002
- Frank Turley SCABA 1997
- Frank Turley SCABA 2003
- Bill Epps SCABA 2003
- M. Hamburger SCABA 2007

Librarian: Don Garner 580-302-1845 (Cell)
Call or Text. If you get voice mail, please leave a message.

Have an Item for Sale? Item Wanted?

If you have any items that are appropriate for Blacksmiths that you would like to list in the Shop and Swap section (or items you are looking for), please send me your description, contact info, and any photos that you have.

SCABA Swage Blocks

\$200.00 plus shipping.
(Same price to members and non-members.)

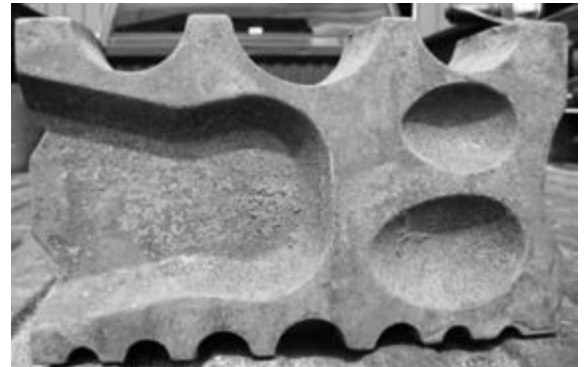

SCABA Floor Cones

\$200.00 plus shipping.

(Same price to members and non-members.)

To order swage blocks or cones, contact our distributor:

**Nolan Walker at
Nature Farms Farrier
Supply in Norman,
OK.**

405-307-8031



SCABA Shop and Swap

Club Coal:

Saltfork Craftsmen has coal for sale. Coal is in 1-2" size pieces. The coal is \$140.00/ton or .07 /pound to members.

No sales to non-members.

NW Region coal pile located in Douglas, OK. If you make arrangements well in advance, Tom Nelson can load your truck or trailer with his skid steer loader for a fee of \$10 to be paid directly to Tom. Tom has moved his skid steer and must now haul the loader to the coal pile to load you out, hence the \$10 charge. You may opt to load your own coal without using Tom's loader. The coal can be weighed out at the Douglas Coop Elevator scales. Contact Tom Nelson (580-862-7691) to make arrangements to pick up a load. Do not call Tom after 9 PM!! Bring your own containers and shovels. Payment for the coal (\$.07 per pound) should be made directly to the Saltfork Treasurer.

NW Region Coal Pile in Thomas:

Don Garner now has a new pile of club coal available for sales to SCABA members. The shop is at 23713 E 860 Rd in Thomas, OK. (One mile west, then one mile north of Thomas.) Contact Don at 580-302-1845 (Cell Phone) to arrange details for purchases.

NE Region coal location: Charlie McGee has coal to sell. He lives in the Skiatook, Oklahoma area. His contact information is: (Home) 918-245-7279 or (Cell) 918-639-8779

Please text his cell phone number if you would like to make arrangements to get coal.

S/C region coal location: Club coal is now available at Norman at Byron Doner's place. Call Byron to make arrangements to come by and get coal.

SCABA T-Shirts!

2018 Saltfork Collector T-shirts are available with the 2018 Conference Logo. \$20.00 (plus shipping if applicable.) Contact Josh Perkins to check sizes and quantities that are still available.



Legacy SCABA T-shirts and long sleeve denim shirts are also available on clearance while supplies last. T-Shirts are \$5.00 and Denim Shirts are \$10.00. (Plus shipping if applicable.) Contact Josh Perkins to check sizes and quantities that are still available.

If you would like to purchase shirts, contact Josh Perkins (918) 269-3523.



Have an Item for Sale? Item Wanted?

If you have any items that are appropriate for Blacksmiths that you would like to list in the Shop and Swap section (or items you are looking for), please send me your description, contact info, and any photos that you have.



SCABA Membership Application

For Annual Membership

(Please Print Clearly!)

Date _____

New Member	_____
Renewal	_____

First Name _____ Last Name _____

Married? _____ Yes _____ No _____ Spouse's Name _____

Address _____

City _____ State _____ Zip _____

Phone (Best Number to Contact) (_____) _____

e-mail _____

ABANA Member? _____ Yes _____ No _____

I have enclosed \$30.00 for dues for one year membership from the date of acceptance.

Signed: _____

Return to: Saltfork Craftsmen, 6520 Alameda, Norman, OK 73026

Note: Registration online by Paypal OR credit card is available from the website.

www.saltforkcraftsmen.org

You do NOT need a Paypal account to use your credit card and registration/renewal is immediate.



Saltfork Regional Meeting Hosting Form

Region: _____ NE _____ SE _____ SW _____ NW

Date: Month _____ Day _____ Year _____

Name: _____

Meeting Address: _____

Host Phone (Best Number to Contact) (_____) _____

Host e-mail _____

Trade Item: _____

Lunch Provided: _____ Yes _____ No

Please provide detailed directions and/or a map to meeting location if possible. Meetings are scheduled on a first come basis.

Return to: Saltfork Craftsmen Regional Meeting Coordinator, Russell Bartling

70 N 160th W Ave

Sand Springs, OK 74063

You can also send the information in an e-mail or text or fill out the online form available on the website in the top banner of the Calendar Tab: www.saltforkcraftsmen.org/Calendar.shtm

Saltfork Craftsmen Artist Blacksmith Assoc. Inc.
6520 Alameda
Norman, OK. 73026

Non Profit Organization
U S Postage Paid
Oklahoma City, Ok
Permit #2177

Address Service Requested

